

KENT
Mineral RO™
 Water Purifiers
 HOUSE of PURITY



Marketed by:
KENT RO SYSTEMS LTD.
 E-6, 7 & 8, Sector-59, Noida, U.P.-201 309, India.
 E-mail: sales@kent.co.in | Website: www.kent.co.in

Manufactured by:
KENT RO SYSTEMS LTD.
 1) Khasra No. 93, Village-Bantakhedi, Tehsil-Roorkee,
 District-Haridwar, Uttarakhand-247 668, India.
 2) A-6, Sector-87, Noida-201 305, U.P., India.

For customer complaints, contact our Customer Care Officer at:
 E-6, 7 & 8, Sector-59, Noida, U.P.-201 309, India. Call: 92-789-12345
 E-mail: service@kent.co.in or visit us at www.kent.co.in

KENT ACE
 FOR MOUNTING ON KITCHEN WALL

KENT
Mineral RO™
 Water Purifiers
 HOUSE of PURITY

Instructions Handbook



KENT TECHNOLOGY

Removes Dissolved Impurities
 Retains Essential Minerals
 Multiple Purification

RO + UF + TDS Control + UV in Tank

Kent Deta Hai

**Sabse
 Shudh Paani**

Mineral RO © 2005 - KENT RO SYSTEMS LTD.
 The process & purifier is patented vide patent no. 199716.
 KENT ACE design is registered vide registration no. 260986



Welcome to KENT

Dear Customer,

At the outset, allow us to thank you for your trust in KENT water purifier. We take pride in our reputation for product quality and industry proven performance. We are certain that your decision to own KENT ACE Mineral RO™ water purifier will go a long way towards keeping you and your family in good health. We are confident that you will be satisfied with its performance and that it will serve your need for safer and cleaner drinking water without any compromise.

This guide will help you in getting the best out of your water purifier. Please go through this booklet to familiarise yourself with its operation and maintenance.

You can look forward to years of trouble free service. To ensure that the warranty of your water purifier is effective, it is important that you fill up the enclosed warranty card and mail us the installation report within 15 days of purchase. In case you need any further information, contact your nearest KENT dealer or branch.

Best Wishes,

KENT RO SYSTEMS LTD.

Table of Contents

1.	KENT Technology - A Breakthrough in Water Purification	1
2.	Salient Features of KENT ACE	1
3.	Items in the Box	1
4.	Important Instructions	2
5.	Reverse Osmosis Process	3
6.	UV Process	3
7.	Water Flow Diagram	4
8.	Electrical Circuit Diagram	4
9.	UV LED Failure alarm	5
12.	Automatic Operation	5
13.	Installation Instructions	5
14.	TDS Adjustment	7
15.	Starting-up the Purifier	7
16.	Recommended Usage of Rejected Water	7
17.	Maintenance	7
18.	Important Safety Instructions	8
19.	Technical Specifications	9
20.	Testing Information	9

KENT TECHNOLOGY - A Breakthrough in Water Purification*

Presenting the KENT ACE Mineral RO™ Water Purifier; it uses futuristic and state-of-the-art technology to provide pure & healthier drinking water.

The heart of KENT ACE Mineral RO™ Water Purifier is a Reverse Osmosis membrane having capillaries as small as 0.0001 microns that reduces even dissolved impurities (salts and heavy metals) and even converts hard water to sweet and purer drinking water. KENT ACE Mineral RO™ Water Purifier also allows the user to control the Total Dissolved Solids (TDS) level of purified water.









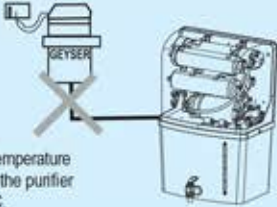
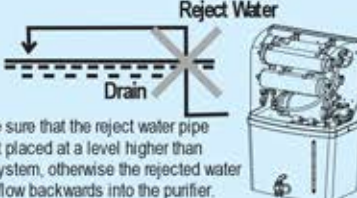

Salient Features of KENT ACE Mineral RO™ Water Purifier

- Water purifier with UV Disinfection in tank to keep purified water pure
- High water recovery**
- Wall-mountable KENT Technology water purifier
- Purification by RO + UF + TDS Control + UV in tank makes water pure
- Inbuilt TDS Controller that allows adjustment of TDS level of purified water
- Suitable for Purification of Brackish / Tap Water/ Municipal Water Supply
- 8 L storage tank with water level indicator
- Fully automatic operation, with auto-on and auto-off function
- RO Membrane fused inside membrane housing to prevent tampering
- Vertically mounted SMPS for protection from water
- Use of push-fit fittings for leakage and maintenance free performance
- Compact design, takes less space for installation
- ABS construction for corrosion free use

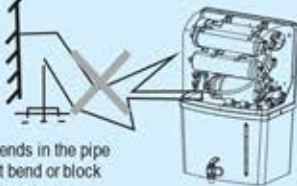
Items in the Box

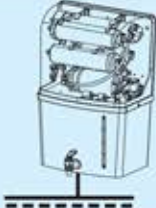
- | | |
|--|----------------|
| 1. KENT ACE Mineral RO™ Water Purifier | : 01 No. |
| 2. 3-Way Connector | : 01 No. |
| 3. S.S. Ball Valve | : 01 No. |
| 4. Food Grade Pipe - 1/4 inch (White) | : 2.5 m |
| 5. Food Grade Pipe - 3/8 inch (White) | : 2.5 m |
| 6. Warranty Card | : 01 No. |
| 7. Screws & Plastic Inserts | : 02 Nos. each |
| 8. Sticker Center Drill | : 01 No. |

Important Instructions

 <p>Avoid exposure to direct sunlight and installation in damp areas.</p>	 <p>Make sure that the temperature of the water entering the purifier is within 10° C - 40° C.</p>
 <p>Make sure that the reject water pipe is not placed at a level higher than the system, otherwise the rejected water may flow backwards into the purifier.</p>	 <p>Maximum distance between the water source and the purifier should not be more than 3 meters.</p>
 <p>Avoid sharp bends in the pipe fittings. Do not bend or block the reject water pipe.</p>	 <p>Do not confine the purifier in a cabinet.</p>
 <p>In case of not using the purifier for more than two days, kindly switch off the power supply and drain the storage tank.</p>	 <p>To keep the storage tank clean, it should be drained once in 15 days.</p>
<div style="text-align: center;">  <p>Use Genuine KENT Spares for optimum performance.</p> </div> <div style="display: flex; justify-content: space-between; align-items: center;"> <div data-bbox="1681 1098 1798 1236">  <p>Do not try to service the purifier on your own. Instead, call a technician for help.</p> </div> <div data-bbox="1904 1098 2038 1276">  </div> </div>	

* Tested & certified by TUV-SUD South Asia (P) Ltd. **High water recovery is based on standard testing conditions

Reverse Osmosis Process

The Reverse Osmosis process, also known as hyper filtration, is the finest filtration process known till date. The process ensures reduction of particles as small as ions from a solution. Reverse Osmosis uses a semi-permeable membrane to reduce salts from potable / brackish water. In Reverse Osmosis, water pressure applied to the concentrated side forces the process of osmosis into reverse. Under enough pressure, treated water is "squeezed" through the membrane from the concentrated side to the diluted side. Salts dissolved in water as charged ions are repelled by the RO membrane. The rejected impurities on the concentrated side of the membrane are washed away in a stream of waste water and thus do not get accumulated as in a traditional filter.

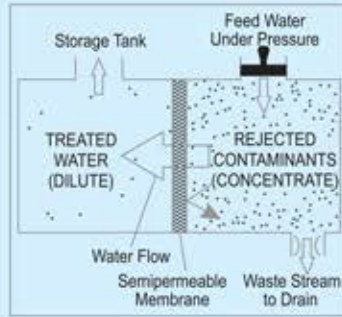

UV Process

The UV light has shorter wavelength (higher energy) than the visible light. It is called ultra-violet because it is just beyond violet light in the light spectrum. Technically, the ultra-violet light is defined to be any wavelength of light, which is shorter than 400 nanometer.

UV rays, which penetrate into the micro-organisms, are absorbed by the DNA of the pathogen in the water. The DNA is altered in such a way that the pathogen cannot reproduce itself. Thus, it is essentially killed and cannot cause infection. This process of DNA modification is called inactivation.

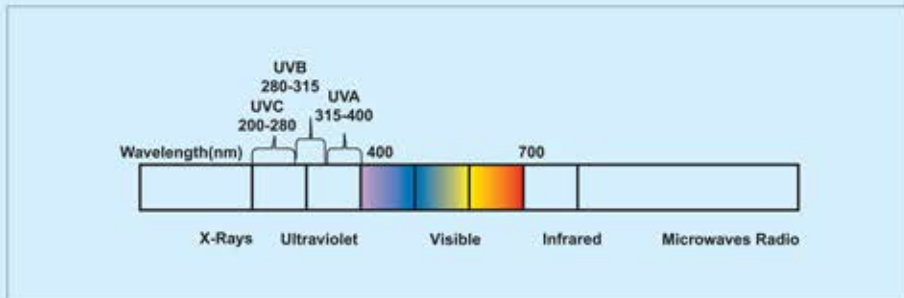

Water Flow Diagram

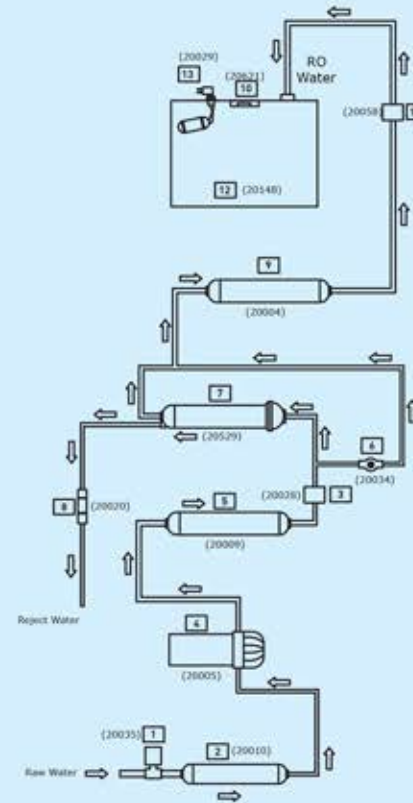

S.NO.	SPARE PART CODE	ITEM DESCRIPTION
1	20035	LOW PRESSURE SWITCH
2	20010	SEDIMENT FILTER
3	20028	SOLENOID VALVE
4	20005	BOOSTER PUMP
5	20009	ACTVATED CARBON FILTER
6	20034	TDS CONTROL VALVE
7	20529	RO MEMBRANE
8	20020	FLOW RESTRICTOR TUBE
9	20004	UF MEMBRANE
10	20621	UV LED
11	20058	NON RETURN VALVE
12	20148	WATER STORAGE TANK
13	20029	FLOAT MICRO SWITCH

Electrical Circuit Diagram

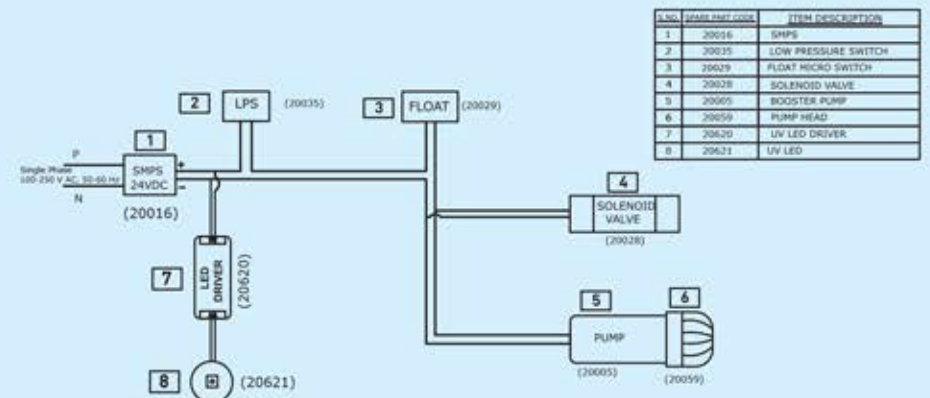

S.NO.	SPARE PART CODE	ITEM DESCRIPTION
1	20016	SMPS
2	20035	LOW PRESSURE SWITCH
3	20029	FLOAT MICRO SWITCH
4	20028	SOLENOID VALVE
5	20005	BOOSTER PUMP
6	20059	PUMP HEAD
7	20620	UV LED DRIVER
8	20621	UV LED

[NOTE: The above specifications are subject to modifications for improvement without notice].

UV LED Failure alarm*

KENT ACE Mineral RO™ Water Purifier has an in-built feature that sounds an audible alarm if the UV lamp malfunctions. This feature is provided to ensure purity. This UV Fail Alarm will sound as following:
Two short beeps after every two seconds.



In case such an alarm is audible, kindly switch off the purifier and call the service technician for help. The purifier will stop its purification process in such a circumstance.

Automatic Operation

- The purifier automatically shuts off when the storage tank is full
- The purifier does not start when inlet water supply pressure falls below 0,3 kg/cm²
- The purifier automatically restarts when water level drops below the maximum
- The purifier does not allow any water rejection in absence of electricity / when tank is full

Installation Instructions

The KENT ACE Mineral RO™ Water Purifier is a product of advanced technology, which ensures safe and clean drinking water. The purifier is easy and convenient to install.

Recommended Site Preparations:

- Single Phase 100-250 V AC, 50-60 Hz. connection not more than 3m away from the point of installation of purifier
- Raw water supply with 1/2 inch nipple not more than 3m away
- Drain for rejected water not more than 3m away
- Space as per dimensions of the purifier
- Wall/plane surface for mounting two screws and holding the machine
- The system and installation must comply with state and local laws and regulations

Specific Instructions:

- KENT ACE Mineral RO™ Water Purifier is a wall-mounted purifier. Make sure that it is only mounted on a wall. Avoid installation on wooden and metallic stands
- For optimum performance and minimum inlet pressure required, ensure that the raw water supply tank is at least 10 ft above the level at which the purifier is installed
- It is preferable to install the purifier near a sink so that inlet and reject water lines are easily available

* Tested & certified by TUV-SUD South Asia (P) Ltd.

Installation Procedure:

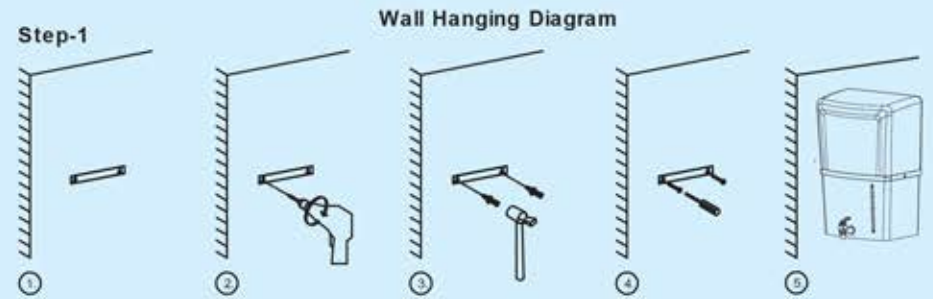

1. Paste the central drill sticker on wall at (3.6 feet to 4.0 Feet from the ground) as per your convenience.
2. Ensure that the sticker is pasted straight on the wall, then drill holes as per the space provided on sticker.
3. Now, insert the puff up with the help of a hammer.
4. Screw in two 10X50 self-taping screws, 5,4 inches (138 mm) apart horizontally.
5. Carefully hang the purifier on the wall with the help of wall-mounting slot holes provided on the back side of the purifier.

Note:

1. If the wall is not straight or the screws are not properly drilled in an even position, it will damage your purifier.
2. Keep the device away from heat or direct sunlight.

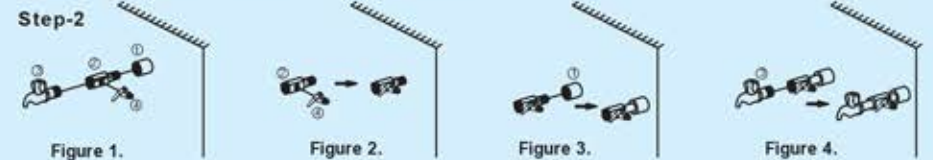

1. First fix the SS ball valve (marked as no. 4) to the 1/4 inch port of the 3-way connector (marked as no. 2) as shown in figure 2.
2. Connect the 3-way connector to the raw water supply (marked as no. 1) as shown in the figure 3. The 3-way connector is fit in line with the raw water supply.
3. The other end of the 3-way connector can be connected to a tap (marked as no.3) as shown in figure or can be plugged off if not required.

Step-3

1. Now connect one end of the white pipe to SS ball valve and another end to the upper push-fit elbow fitting to the left hand side of the purifier labelled as WATER IN, as shown in fig 1.
2. Similarly, connect one end of the white pipe to the lower elbow fitting connector in tank labelled as REJECT WATER and leave the other end in the drain, as shown in fig 2.

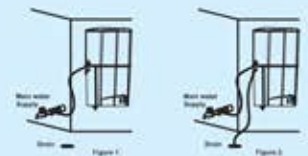

Step-4

Before connecting the power supply, it is important that you perform the following functions:

1. Open the SS ball valve (Handle parallel to the ball valve) to start the flow of water into the purifier, as shown in the figure.
2. Wait for 2-3 minutes to ensure that the filters are soaked in water.



Step-5

1. Connect the power supply.
2. Installation is complete.

TDS Adjustment*

The unique TDS Controller enables customers to retain the contents of natural minerals in purified water, as per their requirement.

- Turning the screw of the valve anti-clockwise, results in an increased mineral content.
- Turning the screw of the valve clockwise, results in a decreased mineral content.

Starting-up the Purifier

- Switch on the power supply the pipes and storage tank.
- Wait till the storage tank fully fills up**
- Switch off the power supply
- Drain the storage tank by opening the drain plug present at the bottom of the storage tank so as to remove any dust particles present in
- Close the drain plug & switch on the power supply
- The purifier is ready to use.

Recommended Uses of Rejected Water

Rejected water has high concentration of salts and usually goes down the drain, but if required, can be used for gardening purposes. It has high concentration of salts and minerals which accelerate plant growth. Rejected water can also be used for cleaning purposes, i.e. utensils cleaning, mopping the floor etc.

Maintenance

To ensure that the purifier operates at its optimum level, a routine maintenance must be performed. The frequency of the maintenance will greatly depend upon the raw water quality and consumption of treated water.

- Storage tank must be drained once in 2 weeks. To do so, switch off the power supply, open the drain plug at the bottom of the tank & allow the water to drain. Then screw back the plug and switch on the power supply.
- Replace sediment, activated carbon & post carbon when the filter change alarm is audible OR after every 12 months. It is recommended to change the FRT when the filters are replaced.
- Replace the RO membrane once in a year
- If you are not going to use the purifier for a long time (in case you are on a holiday, tour or out of home), make sure that you disconnect the power supply, turn off the raw water supply and drain the storage tank.

The reverse osmosis system contains a replaceable treatment component critical for the effective reduction of total dissolved solids and that product water shall be tested periodically to verify that the system is performing properly.

* Tested & certified by TUV-SUD South Asia (P) Ltd.

** Tested or certified flushing time - 24hrs.

Replacement of spare parts are as under:

-20010	SP	Inline Sediment Filter 8"
-20009	SP	Inline Carbon Filter 8"
-20529	SP	RO Membrane
-20015	SP	Post Carbon Filter (Blue)
-20003	SP	Hollow Fibre Membrane (RO)
-20020	SP	FRT 300/450

Note: Filters and membranes are consumables. Their replacement time depends upon the quality of raw water and water consumption. They are not covered under the warranty. However, if a filter chokes within six months and a membrane within a year, it will be cleaned/repared/replaced free of cost. Changing the filters and system inspection is available on call. The treatment capacity of RO membrane will reduce with time due to clogging of pores of membranes.

This reverse osmosis system contains a replaceable component critical to the efficiency of the system. Replacement of the reverse osmosis component should be with one of identical specifications as defined by the manufacturer, to ensure the same efficiency and contaminant reduction performance.

Important Safety Instructions

- If the supply cord is damaged, it must be replaced by the original part in order to avoid hazard.
- Children should be supervised to ensure that they do not play with the appliance
- This appliance is not intended for use by persons (including children) with reduced physical/sensory or mental capabilities, or lack of experience and knowledge, unless they have been given supervision or instruction concerning use of the appliance by a person responsible for their safety.

Technical Specifications

Product	KENT ACE
Product Code	11106
Product Generic Name	Water Purifier
Colour	White
Applications	Suitable for Purification of Brackish / Tap Water / Municipal Water Supply
Purification Production Rate	20 L/hr.
Body Material	ABS Food Grade Plastic
Mounting	Wall-mounted
Dimensions (mm)	380 (L) x 270 (W) x 505 (H)
Inlet Water Pressure/Temp (Min.)	0.3 kg/cm ² / 10°C
Inlet Water Pressure/temp (Max.)	4 kg/cm ² / 40°C
Min./Max. Operating pH	6.5-8.0
Filter Cartridge	Sediment, Carbon Filter and UF
UV LED Wattage	0.7 W
Net Weight	7.4 kg
Storage Capacity	8 L
Maximum Duty Cycle	100 L/day
Membrane Type	Thin Film Composite RO
Booster Pump Voltage	24 V DC
Total Power Consumption	60 W
Input Power Supply	Single Phase 100-250 V AC, 50-60 Hz. 
IP Rating	IPX1

* Purification capacity tested for raw water having TDS level of 750 ppm at room temperature.

Testing Information

The System has been tested according to IS 10500:2012 (Standards for drinking water as per Bureau of Indian Standards) for reduction of the hazardous substances.